

ANSAUGROHRSCHUTZ

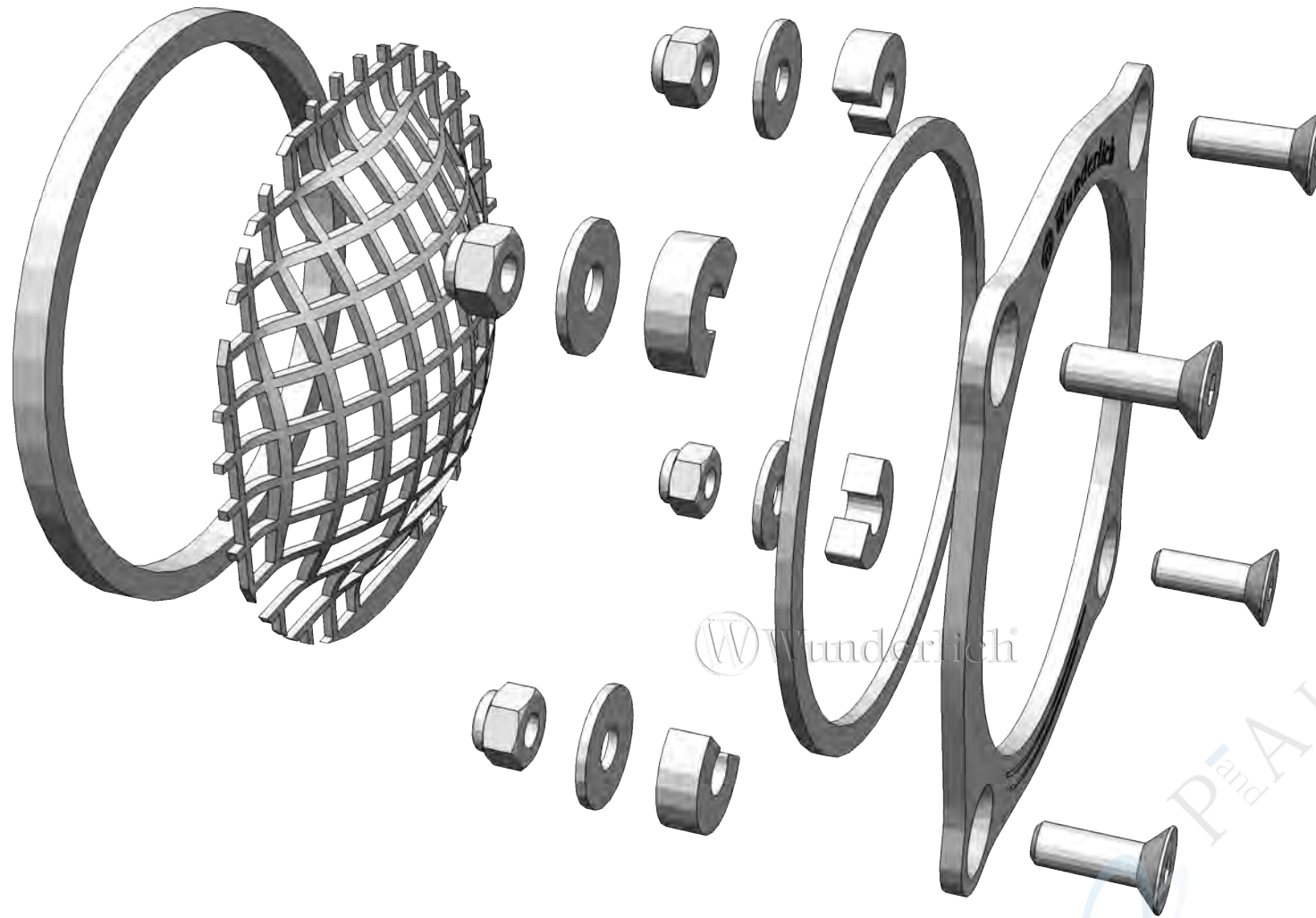

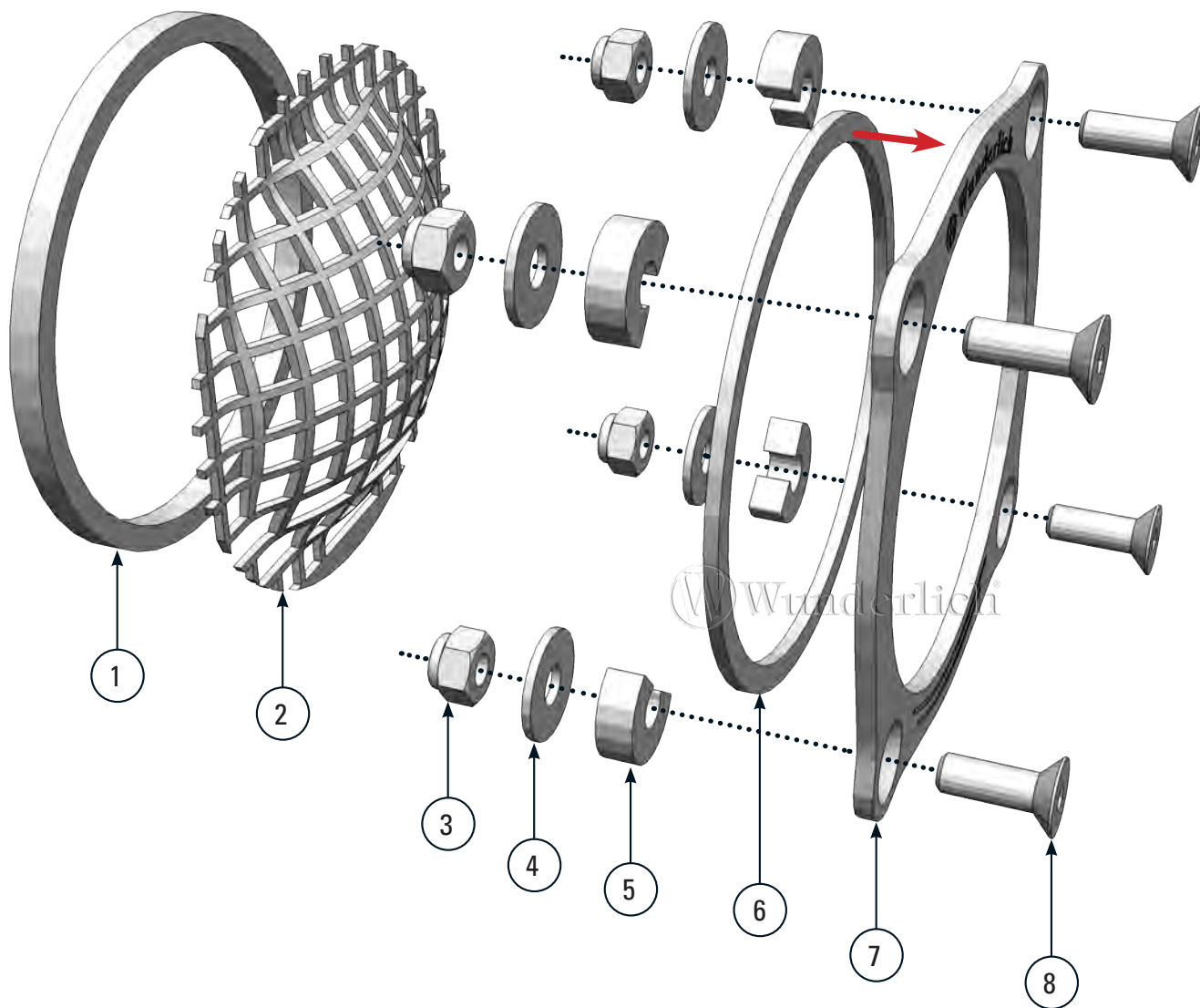



Intake grill | Griglia di aspirazione | Grille de reprise | Rejilla de admisión

Art.-Nr: 42751-002





LEGENDE / KEY

-  Anbau Tipp
Fitting tip
-  Achtung
Attention
-  Vergrößerung
Magnification
-  Schraube
Screw
-  Schraubensicherung
Thread locking fluid
-  M10x14
15 Nm Drehmoment
Torque

#	BEZEICHNUNG / DESCRIPTION	MENGE / AMOUNT
1	Moosgummi-Ring 3,5 mm selbstklebend	1
2	Gitter	1
3	Sechskantmutter M4	4
4	U-Scheibe M4	4
5	Distanzscheibe	4
6	Moosgummi-Ring 1,5mm selbstklebend	1
7	Klemmblech	1
8	Senkkopfschraube M4 x 12	4

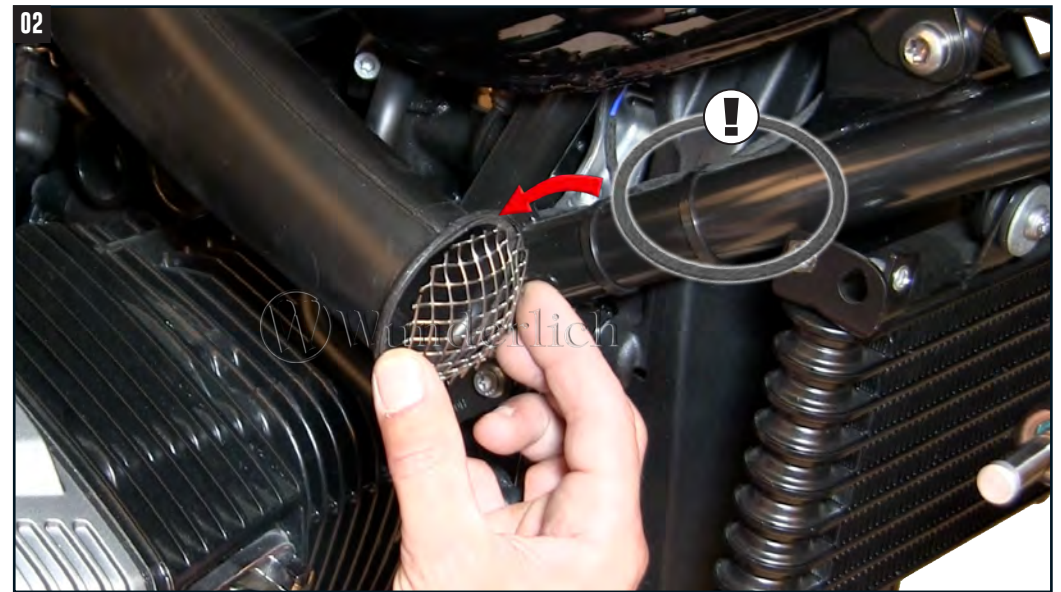

! Moosgummi (Pos.1) in den Ansaugstutzen kleben!
Paste the foam rubber (Pos.1) into the intake manifold!

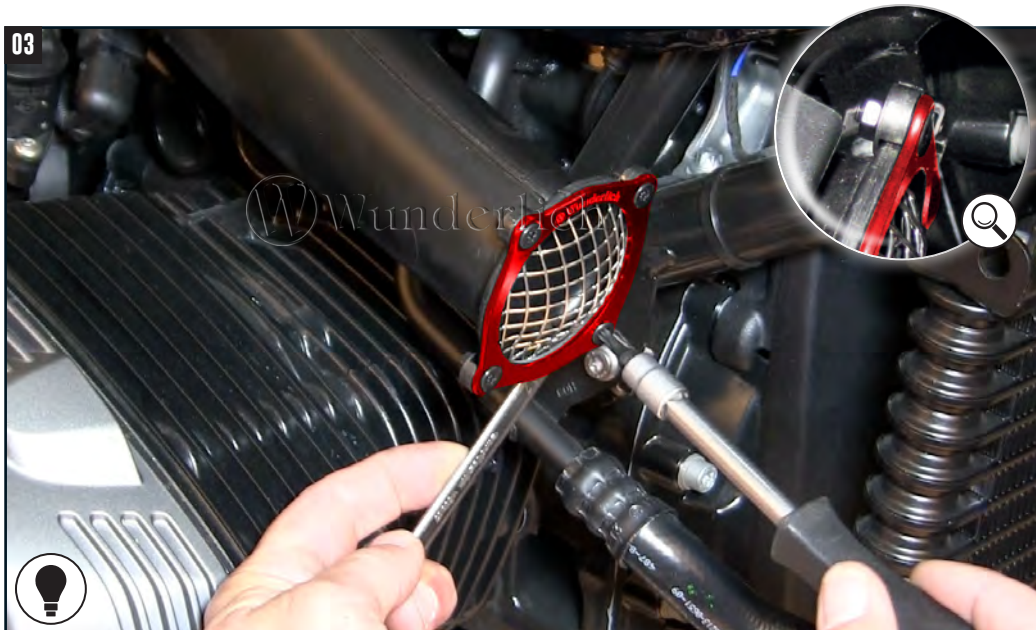

Anbautipp: Montieren Sie im 1. Schritt nur drei Schrauben lose vor. Im 2. Schritt wird der Schutz über den Ansaugstutzen gestülpt und mit der vierten Schraube fixiert und befestigt.
Mounting Tip: Mount in step 1 only three screws loose before. In the second step, the protection is placed over the intake manifold and fixed, and fastened with 4 screws.

