

# RAHMENABDECKUNG

Frame cover | Couverture de cadre | Cubierta de marco | Copertura del telaio

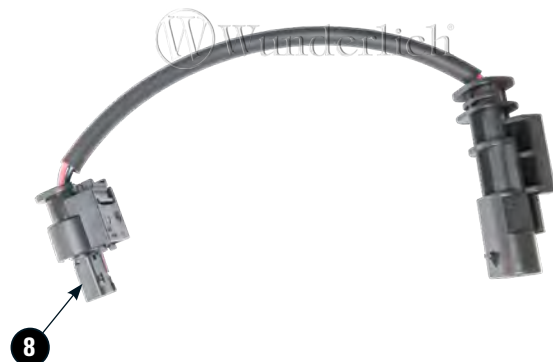







Art.-Nr: 20800-602/702/21X/22X



**Kann bei Bedarf als Verlängerung genutzt werden.**  
*Can be used as an extension if needed.*  
*Peut être utilisé comme extension si nécessaire.*



LEGENDE/KEY/FILE LÉGENDE

-  **Anbau Tipp**  
Fitting tip  
Astuce de montage
-  **Achtung**  
Attention  
Attention
-  **Vergößerung**  
Magnification  
Grossissement
-  **Montagepaste**  
Fitting lubricant  
Lubrifiant de montage
-  **Schraube**  
Screw  
Vis
-  **Schraubensicherung**  
Thread locking fluid  
Freiniflets
-  **Drehmoment**  
Torque  
Torque
-  **Reiniger**  
Cleaner  
Nettoyant

| # | BEZEICHNUNG / DESCRIPTION<br>DE / EN / FR           | Die Farben der Abbildungen dienen nur der Veranschaulichung.<br>The colors are for illustrating purposes only.<br>Les couleurs utilisées sont à titre indicatif seulement. |      |         | DIN     | ISO | MENGE<br>QUANTITY |
|---|---|--|------|---------|---------|-----|-------------------|
| 1 | Rahmenabdeckung (rechts) / Frame cover (right side) |  |      |         |         |     | 1                 |
| 2 | Rahmenabdeckung (links) / Frame cover (left side)   |  |      |         |         |     | 1                 |
| 3 | Linsenflanschschraube / lens head screw             | M6x20  | 8 Nm | 7381SA2 | 7381SA2 |     | 2                 |
| 4 | U-Scheibe / washer                                  | M6   |      | 9021SA2 | 7093    |     | 2                 |
| 5 | Hülse / sleeve                                      | 5,5mm  |      |         |         |     | 2                 |
| 6 | Gummi-Kabelbinder / rubber zip ties                 | 74mm   |      |         |         |     | 6                 |
| 7 | Lackschutzfolie/protection film                     | 20cm   |      |         |         |     | 5                 |
| 8 | Kabelverlängerung / extension cable                 |  |      |         |         |     | 1                 |



**Anliegende Flächen am Rahmen mit Lackschutzfolie bekleben.**  
*Cover points of contact with protection film.*  
*Couvrir les points de contact avec un film de protection.*



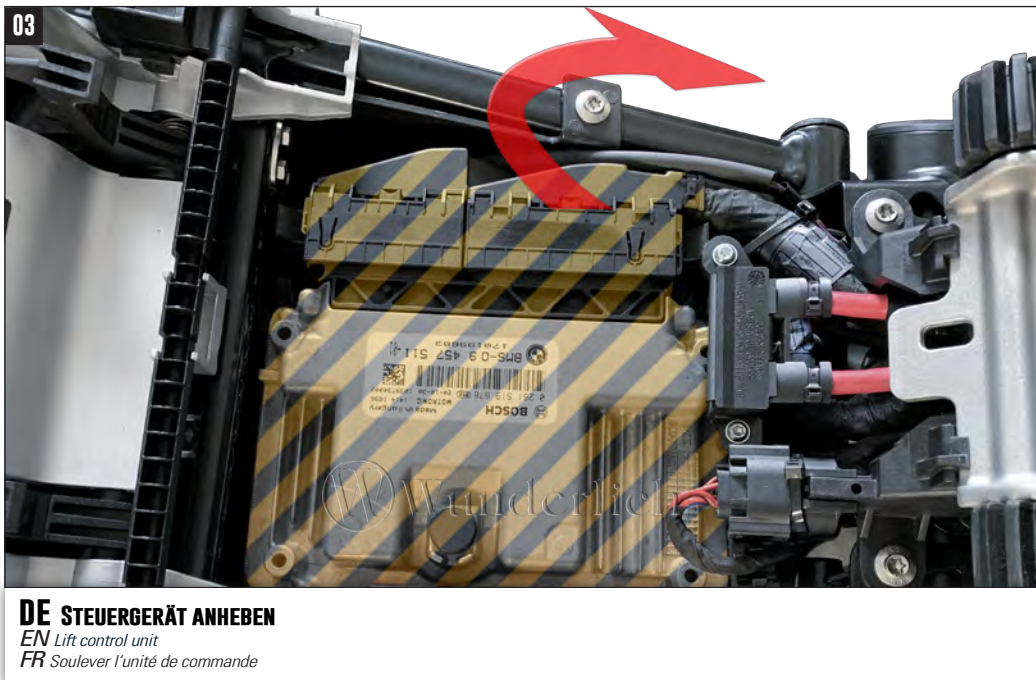
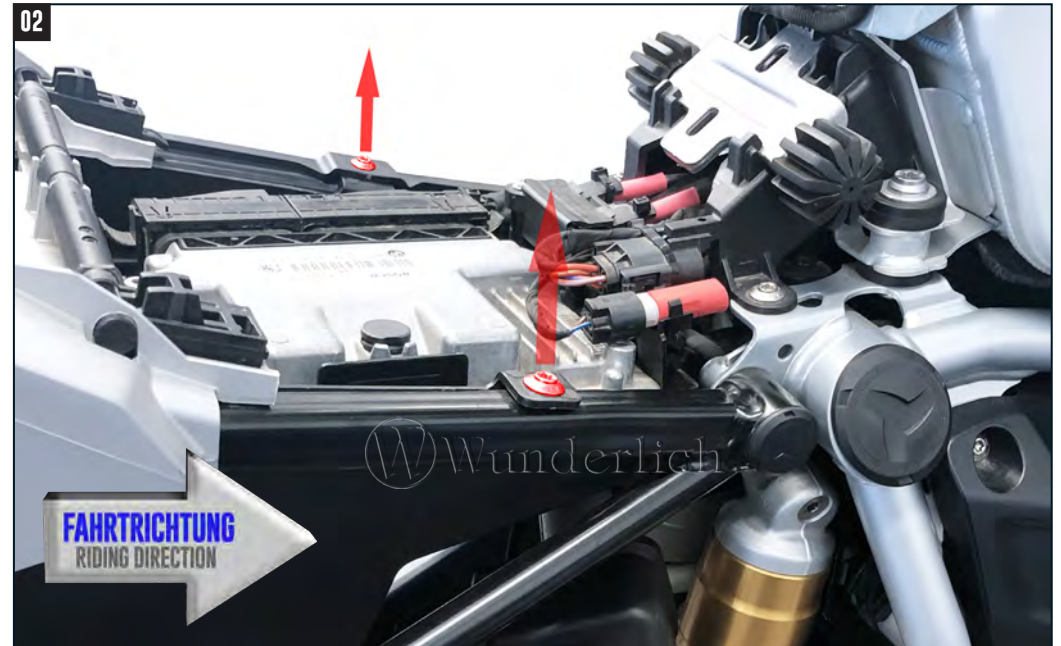
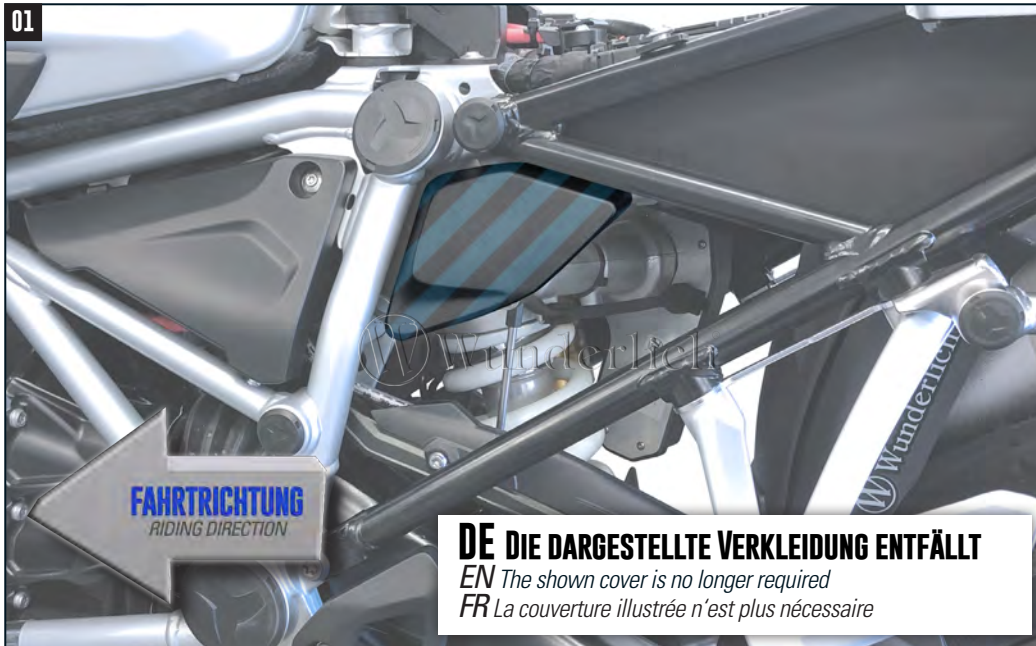

4.2

**LINKS**  
left/gauche



05

**RECHTS**  
right/droite

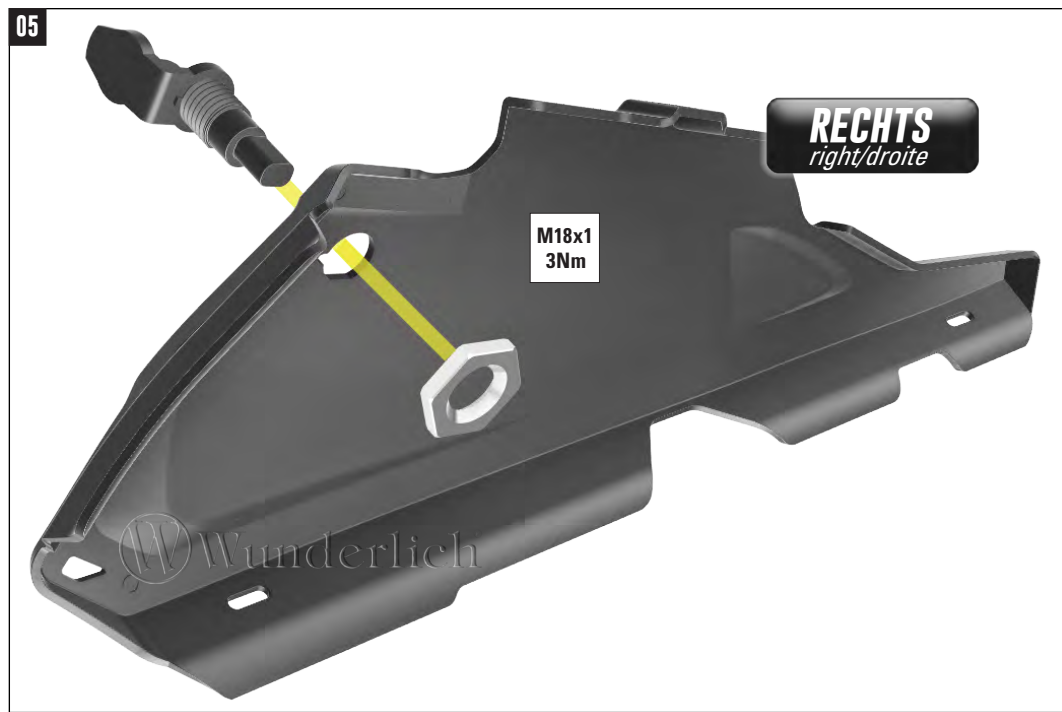

06

**DE KABEL NACH RECHTS VERLEGEN & ANSCHLIEßEN**

*EN Lay cable to the right & connect*

*FR Posez le câble à droite et connectez-le*



07

**M6x20**  
**8Nm**

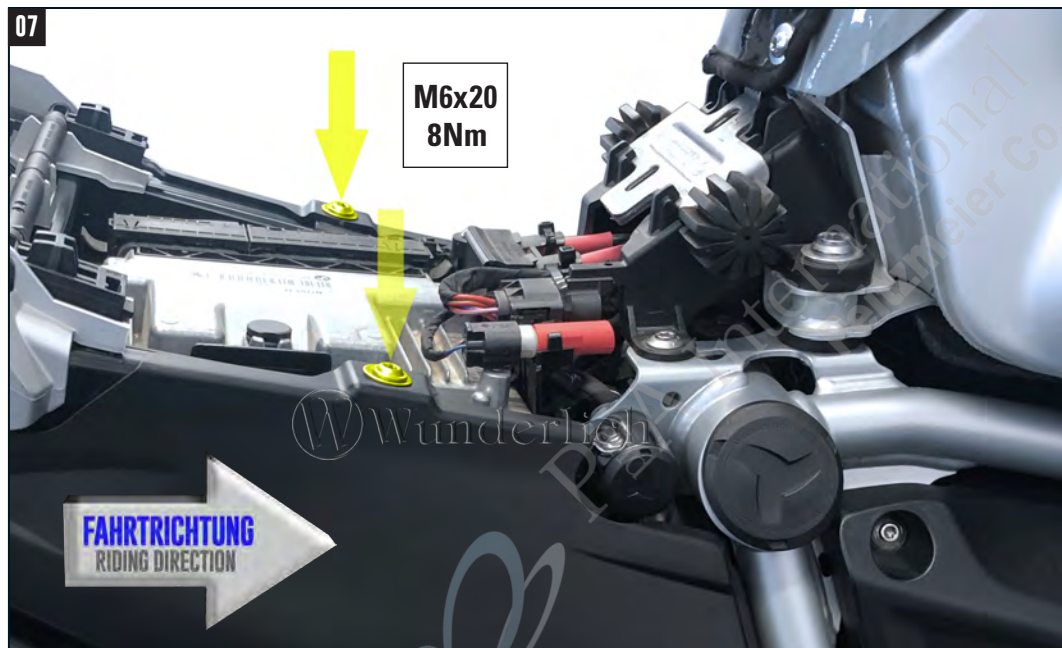



**FAHRTRICHTUNG**  
RIDING DIRECTION

**FAHRTRICHTUNG**  
RIDING DIRECTION